

Introduction	
Operating Modes	1
Installation	1
Power Supply Connection	1
External Signal Connection	2
System Programming	2
408 Remote Control	2
Guarantee	2
Operation with 482D, 4800 and 4850 Master Clocks	
w482 Time Code Operation	3
Stand-alone, MSF, DCF, GPS and Local Synchronised Operation	
Stand-alone Operation	4
MSF, DCF and GPS Operation	4
Local Master Operation	4
Function Programming	5
w482 Code Synchronisation - Zone Allocation	6
Time and Date Setting	7
470A and 475A Calendar Display Programming	11
MSF, DCF and GPS Time Code Synchronisation	12
MSF and DCF installation	12
Alignment	12
Signal Reception	
GPS Sattellite Time Code Synchronisation	13
Mounting Details	
Flush Mounting Cases	14
Surface Mounting Cases	15
External Signal Connection	16

The 470A series of time zone displays are designed to show the local time in a number of different national and international locations. The 470A series comprises a number of different models offering a choice of number of zones, horizontal or vertical display format, character height and calendar display options.

Each time zone is identified with the appropriate city or geographical name to suit customer's requirements.

Operating Modes

470A series time zone displays are user programmable to provide a wide range of operating features.

- 470A series time zone displays can be used as stand-alone units, deriving their timekeeping from a highly accurate internal quartz crystal oscillator, or to operate as slave displays controlled by time signals from many different sources.
- Each time zone can be programmed to automatically adjust for individual seasonal time changes according to British, European or North American conventions.
- In small systems one 470A series display may be used to control up to ten similar units using a simple single cable pair interconnection - *please refer to page 3* for further information. In large systems a 482D, 4800 or 4850 series master clock should be used for centralised control.
- 470A series time zone displays can also be synchronised from:
 - ~ Radio time code signals when connected to a 484 series DCF or MSF radio receiver - *please refer to pages 4, 12 and 13.*
 - ~ GPS satellite time signals when connected to a 488GPS receiver system - *please refer to page 4 and 13.*
 - ~ One minute 6-48v alternate polarity impulses - *please refer to page 3.*
 - ~ w482® multi-zone code signals from a 482, 4800 or 4850 series master clock - *please refer to page 3.*
- The display brightness may be adjusted through a range of 7 settings - *please refer to page 5.*
- Units fitted with a calendar display show the abbreviated day of week, day of month and abbreviated month. The language for the calendar information may be selected from the following list: - *please refer to page 11:*
 - ~Catalan - selection CA
 - ~German - selection D
 - ~Spanish - selection E
 - ~Gallician - selection GA
 - ~Hungarian - selection H
 - ~Italian - selection I
 - ~Dutch - selection NL
 - ~Polish - selection PL
 - ~Swedish - selection S
 - ~Welsh - selection W
 - ~Czech - selection CR
 - ~Danish - selection DK
 - ~French - selection F
 - ~English - selection GB
 - ~Croat - selection HR
 - ~Norwegian - selection N
 - ~Portuguese - selection P
 - ~Russian - selection RU
 - ~Finnish - selection SF

Installation

470A and 474A series time zone displays are available with cases suitable for surface wall mounting, flush mounting in a panel with rear access, flush mounting in a wall box and single or double sided ceiling suspension. The surface wall mounting case is supplied with wall mounting brackets. Please refer to pages 14 and 15 for further mounting information.

Power Supply Connection

470/474A series of time zone displays are manufactured with universal mains power supplies enabling operation at voltages from 100 to 240V ac 50/60Hz without adjustment.

A connection to the earth line must be made to ensure safe operation and compliance with EMC regulations.

To ensure conformance with EN60950:

(A) For installations where the 470/474A clock is to be permanently connected into the mains power circuit, a readily accessible disconnect device should be incorporated in the fixed wiring.

(B) For installations where the 470/474A clock is to be plugged into the mains power circuit, a socketed outlet should be installed near the equipment and should be easily accessible.

All installation work should be performed in accordance with the Sixteenth Edition of the IEE Wiring Regulations, or equivalent local standard.

When time zone displays are used as stand-alone units an internal automatically recharging battery will, when fully charged, maintain the internal time count, for a period normally in excess of 24 hours, if the mains supply is interrupted.

The power supply is fitted with an internal fuse. In case of fault the fuse should only be replaced with a fuse of the same rating, by a suitably qualified engineer **after disconnection from the mains power supply** and correction of the fault condition.

External Signal Connection

A six way terminal block is located on the rear panel of the clock to enable the connection of external signals, radio time code receivers and slave displays. Details of the connections for various signal configurations are detailed on page 16.

The mains power supply must be disconnected when making connections to external signals.

Clocks supplied for ceiling suspension are supplied with flying leads to allow for external connection of mains power and synchronisation signal. Please specify external synchronisation type at time of order to ensure that the 470/474A time zone display is supplied correctly configured.

System Programming

470A series time zone displays are normally supplied factory programmed to operate in accordance with the customer's order specification. The program settings may be checked or altered at any time by following the steps detailed on pages 5 to 11 of this manual. In case of doubt please do not hesitate to contact your supplier or our factory technical support.

408 Remote Control

A 408 Remote control unit is available for to allow remote programming of your 470/474A series time zone display. The 408 Remote control has a range of 3 metres and replicates the buttons located on the rear of the time zone display. When the remote control is used with 474A style time zone displays the remote should be aimed towards the right most time zone when the buttons are pressed. With a 470A time zone display the remote control should be pointed towards the bottom time zone.

If you would like to purchase a 408 Remote control for use with a 470/474A series time zone display, please contact your local sales representative.

Guarantee

The 470A series time zone displays are fully guaranteed, on a return to works basis, against failure due to faulty parts or workmanship for one year from date of purchase. In the event of failure, either within or outside the warranty period, please pack the unit with care and return it to our factory for examination and repair.

w482 Time Code Operation

Most 470/474A time zone displays are used in conjunction with a 482D, 4800 or 4850 master clock. The Master Clock provides centralised control of one or more 470/474A series time zone displays using the w482® time code system.

The w482® signal was developed for controlling electronic clocks, using a single cable pair data interconnection, in electrically noisy environments. A principal advantage of w482® is the ability to provide time information in any one of fifteen different synchronised time zones. All fifteen time zones can be individually configured on the Master Clock to provide automatic seasonal time change correction.

The w482® signal is transmitted at 4-24v amplitude at a rate of 50 bits per second. The signal is virtually immune to electromagnetic interference. One 482D, 4800, or 4850 unit can control up to fifty 470/474A series time zone displays located up to 1km from the Master Clock unit using a simple, non-critical cable pair.

If your 470/474A series time zone display has been supplied with a Master Clock, it will already be programmed so that the individual time zones are set to display the correct w482® zones. (i.e. If the Master Clock is setup so that Zone 1 is New York time, then the zone labelled "New York" on the 470/474A time zone display should be set to Zone 1 or Z1.)

Refer to page 16 for w482® connection information.

If the 470/474A series time zone display is to be used with an existing system, the setup should be checked and adjusted as follows:

- Refer to *page 5 - Function Programming*, and ensure that program PC 07 is set to w482.
- Refer to *page 6 - w482 Code Synchronisation - Zone Allocation*, and check the setup of the various zones. Adjust if necessary.
- If the time zone display is a 470A or 475A unit refer to *page 11 - 470A and 475A Calendar Display Programming*, and check the calendar language setting and the linked time zone.

Once the 470/474A series time zone display is connected to the Master Clock all the time zones should synchronise correctly following the next minute edge.

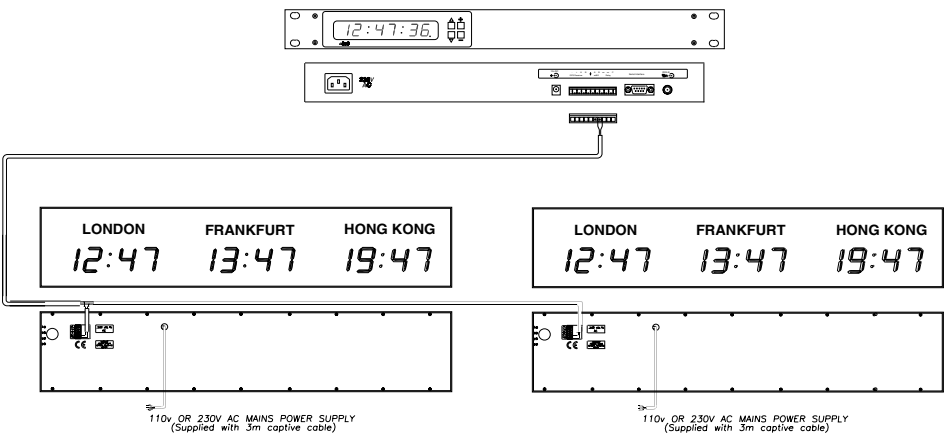

Stand-alone Operation

The 470/474A series of time zone displays can be used as stand-alone displays, deriving the timekeeping from a highly accurate internal quartz crystal oscillator. Each time zone can be programmed to automatically adjust for individual seasonal time changes according to British, European or North American conventions.

The first time zone on the left of the display (bottom time zone for 470A displays) is the master time zone. The master time zone allows the current minutes and seconds values to be set. For the other time zones, the offset from this zone is programmed in 30 minute increments.

The procedure for setting up a 470/474A series time zone display for stand-alone operation is as follows:

- Refer to *page 4 - Function Programming*, and ensure that program PC 07 is set to SA.
- Refer to *pages 7-10 - Time and Date Setting 1-4*, and set the current zone times.
- If the time zone display is a 470A or 475A unit refer to *page 11 - 470A and 475A Calendar Display Programming*, and check the calendar language setting and the linked time zone.

MSF, DCF and GPS Operation

Time zone displays can be used with both the 484 series of MSF and DCF radio receivers and the 488 GPS receiver to provide accurate time synchronisation. Refer to pages 12 - 13 for more information on installing and using MSF, DCF and GPS receivers.

- Refer to *page 4 - Function Programming*, and ensure that program PC 07 is set correctly:
 - ~ PC 07 set to MSF if the 470/474A time zone display is being used with a 484.02 or 484.06 radio receiver.
 - ~ PC 07 set to DCF if the 470/474A time zone display is being used with a 484.03 or 484.07 radio receiver.
 - ~ PC 07 set to GPS if the 470/474A time zone display is being used with a 488 GPS receiver system.
- Refer to *pages 7-10 - Time and Date Setting 1-4*, and set the current zone times. The setting "SM" (Synchronisation Mode - *page 9*) determines whether only the current zone minutes and seconds are synchronised to the input time signal (setting "M"), or if the zone time is completely synchronised to the input signal (setting "C").
- If the time zone display is a 470A or 475A unit refer to *page 11 - 470A and 475A Calendar Display Programming*, and check the calendar language setting and the linked time zone.

Local Master Operation

A 470/474A series time zone display can be used to synchronise 10 other 470/474A displays at a distance of up to 100m using a simple cable pair. When synchronised to a Local Master, only the minutes and seconds of each time zone are synchronised.

- Refer to *page 5 - Function Programming*, and ensure that program PC 07 is set to LOC.
- Refer to *pages 7-10 - Time and Date Setting 1-4*, and set the current zone times.
- If the time zone display is a 470A or 475A unit refer to *page 11 - 470A and 475A Calendar Display Programming*, and check the calendar language setting and the linked time zone.
- Refer to *page 16 - External Signal connection*, for details of how to connect 470A series clocks using the Local Master function.

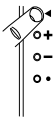

Enter setting mode and step to next stage

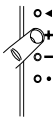

Increment unit values



Zero seconds or decrement other unit values

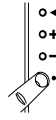

Return to previous level

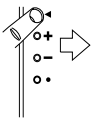

left hand display illuminated
(bottom display on types 470A)

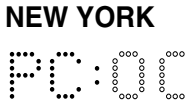
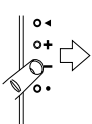

use '+' switch to enter program mode selection stage

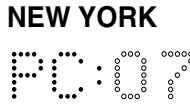
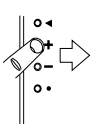

set code for required operating mode selection

Brightness adjustment - set = PC 02
Synchronisation - set = PC 07
Language - set = PC 09
(models with calendar only)

Brightness values:
1 = dim to 7 = bright

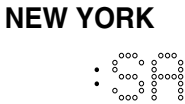
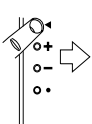

enter operating mode selection stage

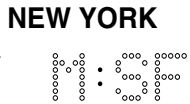
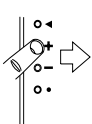

select required operating mode

Synchronisation modes:
SA = stand-alone
W482 = w482 multi-zone time code
GPS = GPS satellite time code
1MIN = one minute alternate polarity 6-48v impulses
MSF = MSF radio time code
DCF = DCF radio time codes
LOC = Sync from 470/474A

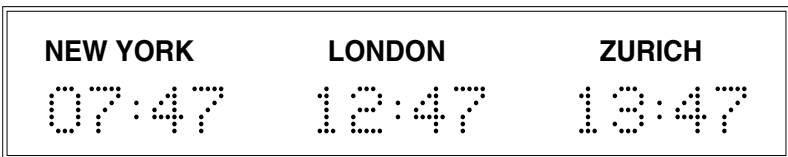
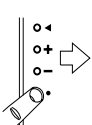

return to normal operation

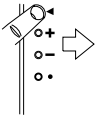

Enter setting mode and step to next stage

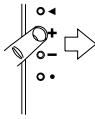

Increment unit values

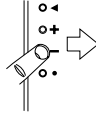

Zero seconds or decrement other unit values

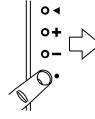

Return to previous level



display in normal operation - controlled by w482 multi-zone time code from a 482 series master clock. Display blank if no code.

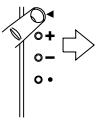

left hand display illuminated (bottom display on types 470)

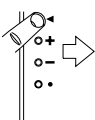

w482 time code zone number for display 1 use '+' & '-' switches to adjust

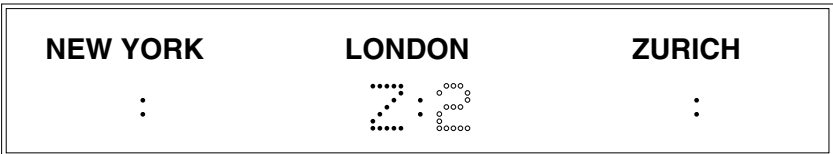
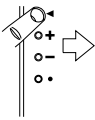

w482 time code zone number for display 2 use '+' & '-' switches to adjust

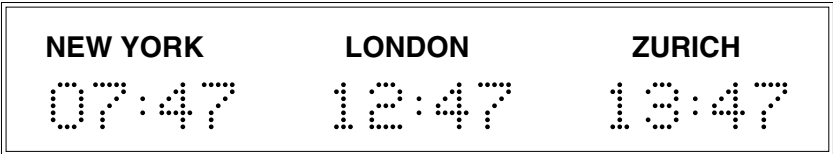
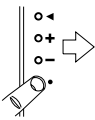

return to normal operation (display will blank until the next time code message is received)

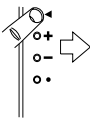

Enter setting mode and step to next stage

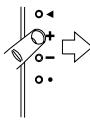

Increment unit values

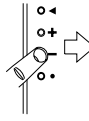

Zero seconds or decrement other unit values

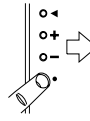

Return to previous level

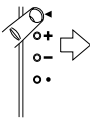

left hand display illuminated (bottom display on types 470A)

press '+' switch to select next zone display

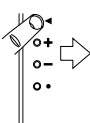

NEW YORK



left hand display of seconds flashes on/off

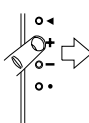

NEW YORK



seconds count increments

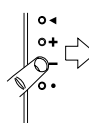

NEW YORK

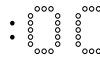

seconds count set to zero

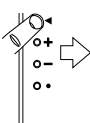

NEW YORK

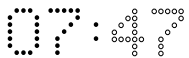

left hand display of minutes flashes on/off

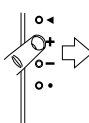

NEW YORK



minutes count increments

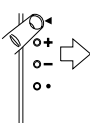

NEW YORK

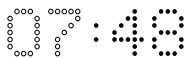

left hand display of hours flashes on/off

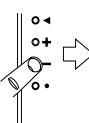

NEW YORK

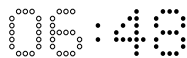

hours count decrements



Please note:

The procedure shown for setting the time for the left hand display (bottom display for types 470A) is different to the procedure for the remaining time zone displays.

The timekeeping of the remaining time zone displays is maintained in synchronisation with the left hand zone display and is adjusted in 30 minute increments. Please refer to following pages for more information.

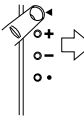

Enter setting mode and step to next stage

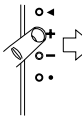

Increment unit values

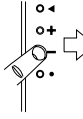

Zero seconds or decrement other unit values

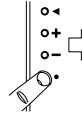

Return to previous level

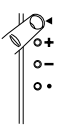

NEW YORK

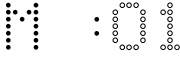

left hand time zone months count flashes on/off

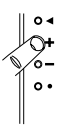

NEW YORK

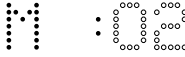

months count increments

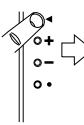

NEW YORK



left hand time zone day-of-month count flashes on/off

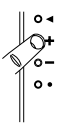

NEW YORK

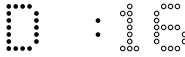

day-of-month count increments

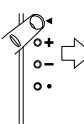

NEW YORK



left hand time zone years count flashes on/off

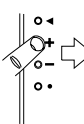

NEW YORK

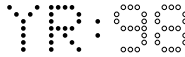

years count increments

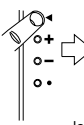

NEW YORK



left hand time zone seasonal changeover mode selection

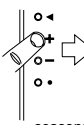

NEW YORK

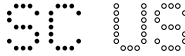

seasonal changeover mode selected (options = '-', 'EU', 'GB' or 'US')

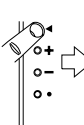

NEW YORK



display of month in which seasonal forward change occurs

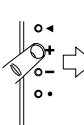

NEW YORK



forward month value changes - value may be 3, 4, 9 or 10

Please note:

If the value '-' is selected for the seasonal change = seasonal change disabled this step and the next three will be automatically skipped.

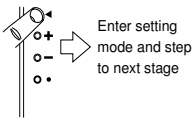

Enter setting mode and step to next stage

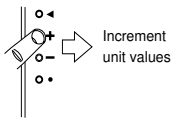

Increment unit values

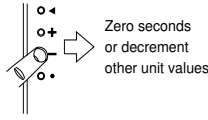

Zero seconds or decrement other unit values

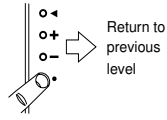

Return to previous level

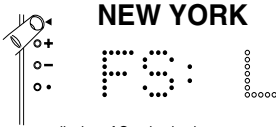

display of Sunday in changeover month on which forward change occurs

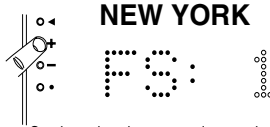

Sunday value changes - value may be 0 (none), 1 (st), 2 (nd), 3 (rd), 4 (th) or L (last)

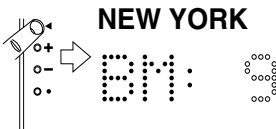

display of month in which seasonal backwards change occurs



backward month value changes value may be 3, 4, 9 or 10

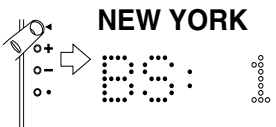

display of Sunday in changeover month on which backward change occurs

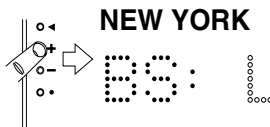

Sunday value changes - value may be 0 (none), 1 (st), 2 (nd), 3 (rd), 4 (th) or L (last)

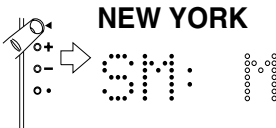

time zone 1 synchronisation mode
M = zone min. & sec. values only
synchronised to the controlling time code

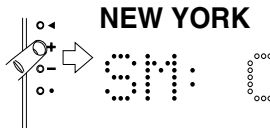

C = all zone time and date values synchronised to the controlling time code

Please Note.

The 'SM' (synchronisation mode) setting option is only displayed if the unit has been programmed for synchronisation with DCF, MSF and GPS time codes

When the SM value is set to 'C' (complete) the individual time zone will automatically display the same time or time and date information as the controlling signal.

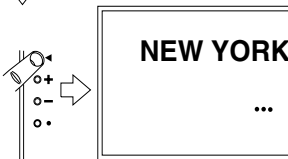

next time zone display selected for setting

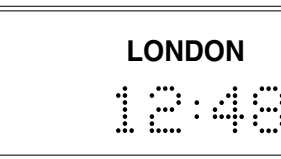

use '-' or '+' switches to select left or right displays



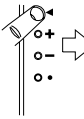

Enter setting mode and step to next stage

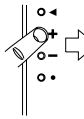

increment unit values

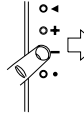

Zero seconds or decrement other unit values

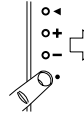

Return to previous level

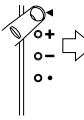

LONDON

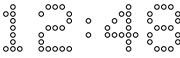

hours and minutes display for time zone 2 flashes on/off

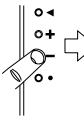

LONDON



hours and minutes values decrement (and increment) in 30 minutes steps

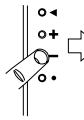

LONDON

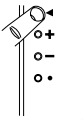

LONDON

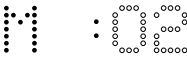

month value for time zone 2 months count flashes on/off

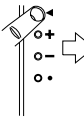

The date setting and seasonal time change programming for time zone 2 and the remaining time zones is identical to that for the left hand display - time zone 1 - described on the previous pages.

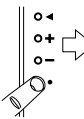

NEW YORK

LONDON

ZURICH

..



⋄

setting of any zone may be terminated at any stage

use '-' or '+' switches to select left or right displays

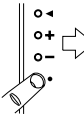

NEW YORK

LONDON

ZURICH

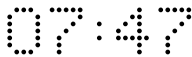

return to normal operation

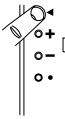

Enter setting mode and step to next stage

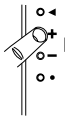

Increment unit values

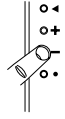

Zero seconds or decrement other unit values

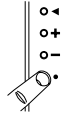

Return to previous level

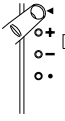

LONDON

:

GB

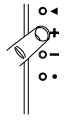

LONDON

:

D



current language code shown in place on month information

'+' or '-' switches used to select required language

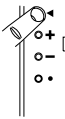

NEW YORK

:

MON 29 JUN

LONDON

:

2

ZURICH

:



'2' indicates that the calendar display is controlled by time zone 2 = LONDON

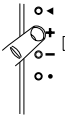

NEW YORK

:

MON 29 JUN

LONDON

:

ZURICH

:

3



'+' or '-' switches are used to select time zone 3 = ZURICH to control the calendar display

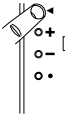

NEW YORK

07:47

MON 29 JUN

LONDON

12:47

ZURICH

13:47



return to normal operation

470A series time zone display units will, when connected to the appropriate 484 series radio receiver and programmed for radio time code synchronisation, automatically synchronise to time and date information transmitted from radio station DCF located at Mainflingen near Frankfurt or from MSF at Rugby.

Only the local or other appropriate zone - refer to 'SM' programming function on page 9 - will be totally synchronised to the radio signal with automatic seasonal time change correction. The minutes and seconds count of the remaining time zones will be maintained in synchronisation with the radio signals, the hours and date count incrementing normally unless altered manually or by an individually pre-programmed seasonal change.

The DCF signal is transmitted at 77.5KHz and is derived from an atomic clock at the Physics Institute of Brunswick. The MSF signal is transmitted at 60KHz and is referenced to the Caesium Beam Oscillator at the National Physical Laboratory.

The type 484.02 (MSF) and 484.03 (DCF) time signal receivers are housed in a compact weather-proof case and are connected to the clock or master clock by a single cable pair. In many locations the receiver will operate within the building. In difficult reception areas, where an external mounting point is required, the receiver unit may be located up to 200 metres from the clock. The type 484.06 (MSF) and 484.07 (DCF) time signal receivers are low cost units for internal use only.

Installation

The 484 series radio time code receiver should be mounted:

- At least 3 metres from the 470/474A series clock.
- At the greatest practical distance from:
Other electrical equipment including computers, fluorescent lights and signs, metal girders and reinforced concrete walls. Any other sources of electrical noise.
- Preferably on the outside of the building (484.02 and 484.03 only) as high as possible. The case is weatherproof to IP65 but it is preferable to provide some protection from direct rain.
- With the cable entry on the lower face of the case (484.02 and 484.03).

The 484 series receiver may be connected to the 470/474A series clock directly by means of the cable provided or, at a greater distance, by means of a suitable extension cable.

At distances of up to 10 metres unshielded two core cable may be used. At greater distances, or in areas of high electrical noise, a two core shielded cable must be used with the screen grounded at one end only. The maximum recommended distance between the receiver and time zone display is 200 metres.

Alignment

The 484.02 and 484.03 radio receivers have dual ferrite antenna which will normally permit installation regardless of orientation to the transmitter. The receiver is mounted by means of the four fixing holes in the rear surface which are accessed after removing the front cover. The four mounting holes are located outside of the central sealed compartment. The 484.06 and 484.07 receivers have a single antenna element and are supplied with an adjustable mounting bracket to enable orientation with the longest face of the receiver at 90° to the direction of the transmitter.

The front cover of the 484.02 and 484.03 receivers may be removed to enable an indicator LED to be viewed. The indicator LED for the 484.06 and 484.07 receiver is located in the front face of the unit. The alignment of the receiver is correct when the LED flashes on/off once per second.

Signal Reception

Under normal circumstances the DCF signal provides reliable operation at distances of up to 1500km. MSF signals are normally usable up to 1000km, with greater operating ranges possible at night. The received and decoded signal provides an operating accuracy of better than +/- 20ms seconds and provides completely automatic seasonal time changes.

In ideal conditions the 470A series time zone display will take three minutes to synchronise with the transmitted time code from either DCF or MSF. When the 470/474A series clock is 'locked' to the transmitted signal the colon between the hours and minutes characters is illuminated continuously. During periods of DCF

and MSF Radio Time Code Synchronisation signal failure or signal corruption the clock will maintain timekeeping using its internal high stability quartz crystal oscillator and the colons on the 'local' display will flash on/off every second.

It should be noted that MSF is off the air for maintenance purposes from 10:00 to 14:00 on the first Tuesday of each month and usually for up to two weeks during the summer months for annual maintenance.

For further information on transmission details please contact:

DCF 77

Physikalisch-Technische Bundesanstalt, Lab. Zeiteinheit

Bundesallee 100

D-3300 Braunschweig

Federal Republic of Germany

MSF

Division of Electrical Science

National Physical Laboratory

Teddington

Middlesex

TW11 0LW

Telephone 020 8943 6493 (Recorded message confirming MSF status)

GPS Satellite Time Code Synchronisation

470A series time zone displays can be synchronised to the time signals from the 21 satellites forming the GPS navigation network.

The GPS satellites transmit highly accurate, real time, worldwide navigation information at a frequency of 1575.42MHz.

The 488GPS receiver system comprises an active antenna and receiver/decoder units which provides a UTC based w482 time code output which can be used to synchronise a master clock system or up to ten individual 470A series time zone displays.

470A series time zone displays synchronised by GPS signals are accurate to within 5mS at any point on the surface of the earth.

The 488GPS system is designed for simple installation and operation. Please request a 488GPS system data sheet for further information.

Flush Fitting Panel Case

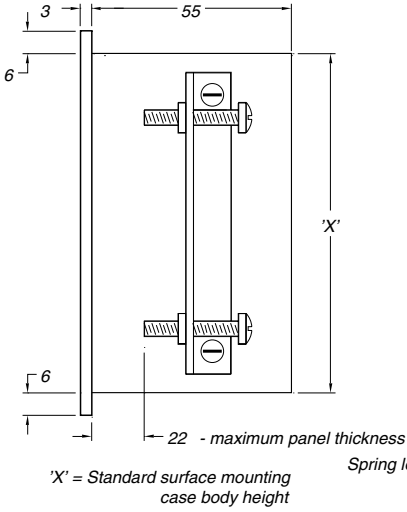

Flush Fitting Case with Mounting Box

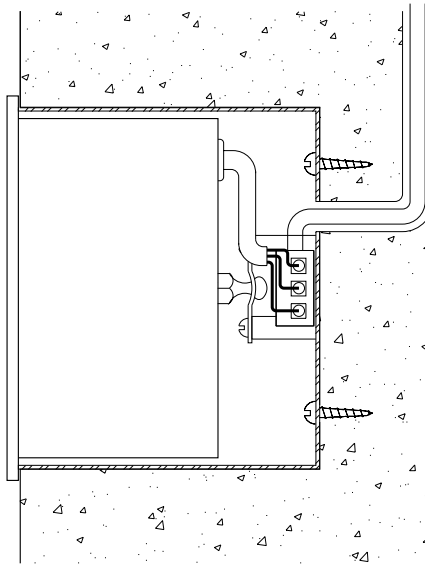
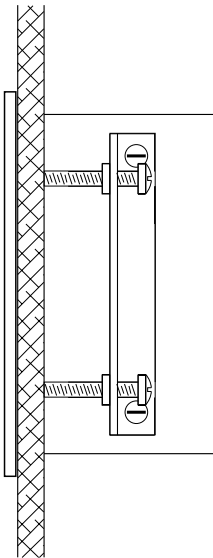
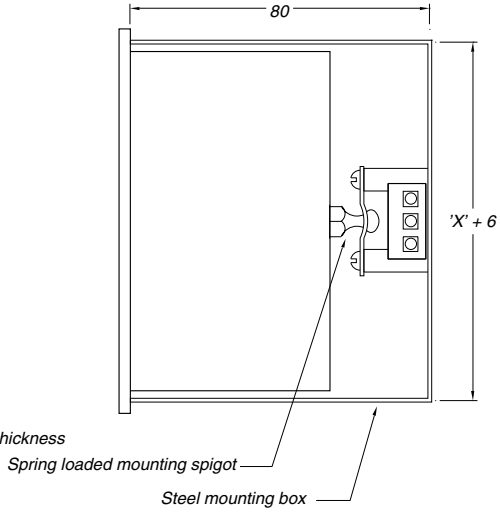

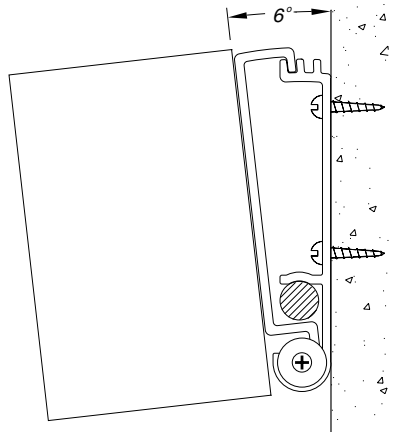
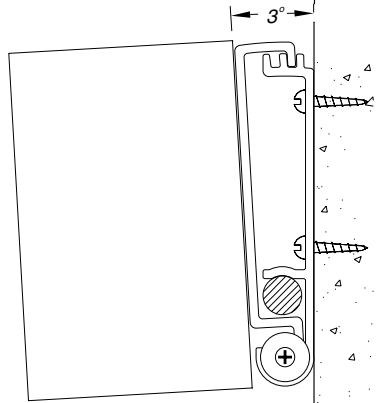
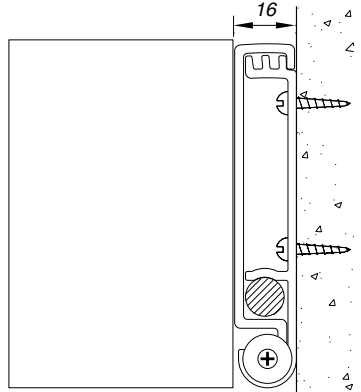
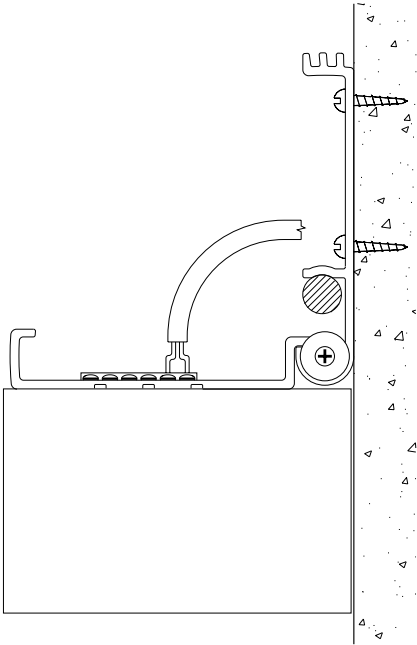

External Signal Connection

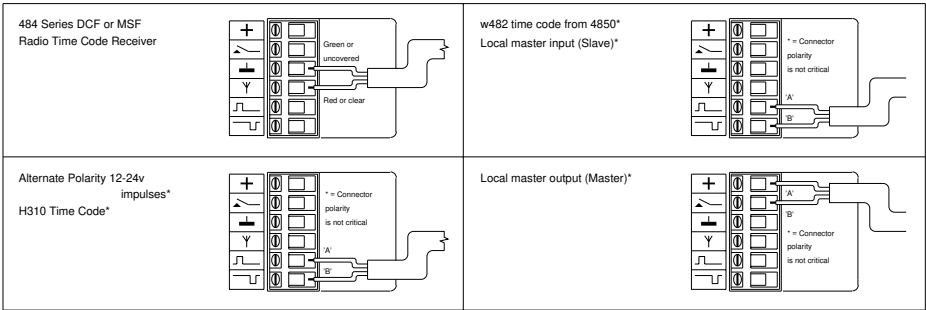
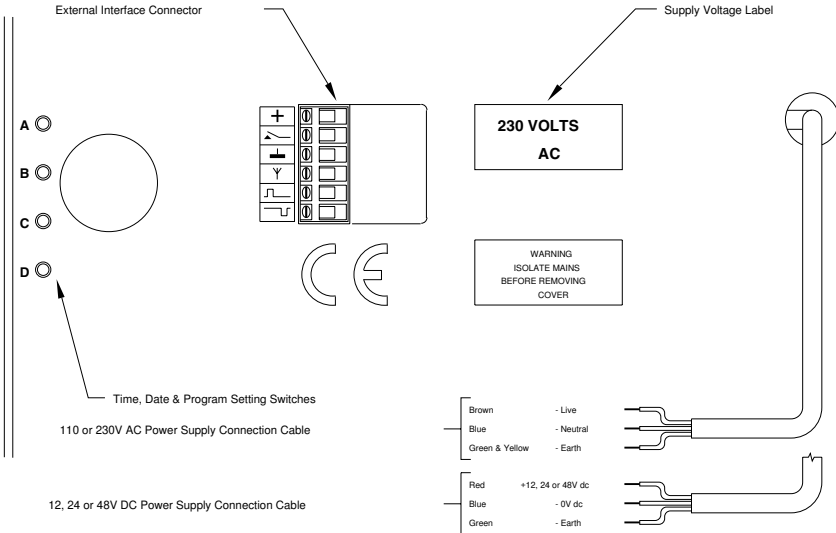

Local Master operation

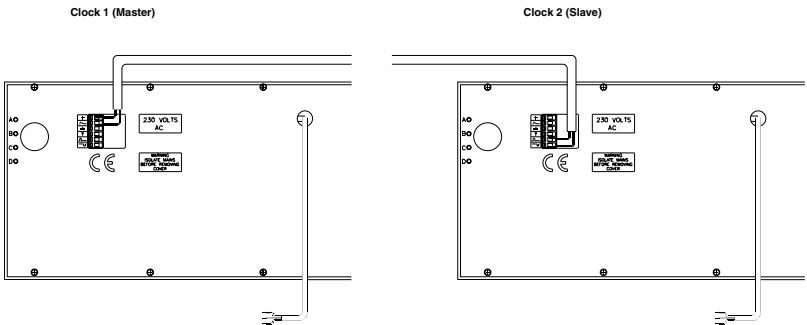

Vortex Communications Ltd

75 The Grove, Ealing LONDON W5 5LL

Email: info@vtx.co.uk

Web: www.vtx.co.uk

Tel: +44 (0)20 8579 2743

Fax: +44 (0)20 8840 0018